



INSTALLATION AND OPERATION MANUAL

XRS SERIES

PASSIVE, POWERED AND OUTDOOR LOUDSPEAKERS

XRS8 / XRS10 / XRS12

XRS8P / XRS10P / XRS12P

XRS60DV / XRS80DV / XRS100DV / XRS120DV



IMPORTANT SAFETY INFORMATION

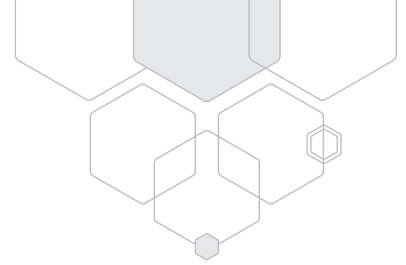

1. **READ** these instructions.
2. Keep these instructions.
3. Heed all warnings.
4. Follow all instructions.
5. Do not use this apparatus near water.
6. Clean only with dry cloth.
7. Do not block any ventilation openings. Install in accordance with the manufacturer's instructions.
8. Do not install near any heat sources such as radiators, heat registers, stoves, or other apparatus (including amplifiers) that produce heat.
9. Do not defeat the safety purpose of the polarized or grounding-type plug. A polarized plug has two blades with one wider than the other. A grounding type plug has two blades and a third grounding prong. The wide blade or the third prong are provided for your safety. If the provided plug does not fit into your outlet, consult an electrician for replacement of the obsolete outlet.
10. Protect the power cord from being walked on or pinched particularly at plugs, convenience receptacles, and the point where they exit from the apparatus.
11. Only use attachments/accessories specified by the manufacturer.
12. Use only with the cart, stand, tripod, bracket, or table specified by the manufacturer, or sold with the apparatus. When a cart is used, use caution when moving the cart/apparatus combination to avoid injury from tip-over.
13. Unplug this apparatus during lightning storms or when unused for long periods of time.
14. Refer all servicing to qualified service personnel. Servicing is required when the apparatus has been damaged in any way, such as power-supply cord or plug is damaged, liquid has been spilled or objects have fallen into the apparatus, the apparatus has been exposed to rain or moisture, does not operate normally, or has been dropped.
15. This appliance shall not be exposed to dripping or splashing water and that no object filled with liquid such as vases shall be placed on the apparatus.
16. Plug this apparatus to the proper wall outlet and make the plug to be disconnected readily operable.
17. Mains plug is used as disconnected device and it should remain readily operable during intended use. In order to disconnect the apparatus from the mains completely, the mains plug should be disconnected from the mains socket outlet completely.
18. **WARNING:** To reduce the risk of fire or electric shock, do not expose this apparatus to rain or moisture.
19. An appliance with a protective earth terminal should be connected to a mains outlet with a protective earth connection.
20. The apparatus should be disconnected from the mains completely before speaker wiring. The speaker output should be proper protected from direct contact and pay attention to speaker connections, terminals and speaker wiring during normal operation.

PRÉCAUTIONS DURANT UTILISATION

1. **LISEZ** ces instructions.
2. Tenez ces instructions.
3. Notez tous les avertissements.
4. Suivez toutes les avertissements.
5. N'utilisez pas ce produit près de l'eau (la piscine, la plage, le lac, etc.).
6. Nettoyez seulement avec une étoffe sèche.
7. Ne bloquez aucuns trous de ventilation. Installez en accord avec les instructions du manufacturier.
8. N'installez près aucunes sources de chaleur comme radiateurs, registres de chaleur, fours ou les autres équipements (y compris amplificateurs) qui produisent la chaleur.
9. Ne défaites pas le but de sécurité de la fiche polarisée ou base-type. Une fiche polarisée a deux tranchants avec un plus large que l'autre. Une fiche de base type a deux a deux tranchants et une troisième pointe de base, le tranchant large ou la troisième pointe est fourni pour votre sécurité. Si la fiche donnée ne conforme pas votre prise de contact, consultez un électricien pour remplacement de la prise de contact obsolète.
10. Protégez le cordon de secteur contre être marchée dessus ou pincé en particulier aux fiches, aux douilles de convenance, et au point où ils sortent de l'appareil.
11. Seulement utilisez attachements/accessoires spécifiés par le manufacturier.
12. Utilisez seulement avec un chariot, un stand, un trépied, un support ou une table indiquée par le manufacturier, ou vendue avec l'appareil. Quand un chariot est utilisé, faites attention en déplaçant la combinaison d'appareil/chariot pour éviter de se déséquilibrer.
13. Arrachez la fiche du dispositif durant éclair et orage ou quand pas utilisé pour longues périodes de temps.
14. Référez au personnel qualifié de service pour toutes réparations. La réparation est donnée quand le système a été endommagé à n'importe façon, par exemple un fil ou une fiche endommagé(e) de la source d'alimentation. Avoir été exposé à pluie ou humidité, n'opère pas normalement, ou avoir été tombé.
15. L'appareil ne doit pas être exposé aux écoulements ou aux éclaboussures et aucun objet ne contenant de liquide, tel qu'un vase, ne doit être placé sur l'objet.
16. Branchez l'appareil à une source appropriée et faire que la prise à débrancher soit facilement accessible.
17. La prise du secteur ne doit pas être obstruée ou doit être facilement accessible pendant son utilisation. Pour être complètement déconnecté de l'alimentation d'entrée, la prise doit être débranchée du secteur.
18. **AVERTISSEMENT:** Pour éviter le risque d'incendie ou de chocs électriques, ne pas exposer cet appareil à la pluie ou à l'humidité.
19. Un appareil avec la borne de terre de protection doit être connecté au secteur avec la connexion de terre de protection.
20. Assurez-vous que l'appareil est hors tension avant de connecter les hauts parleurs. Vérifiez que la sortie des enceintes soit protégées contre un contact physique. Respecter les polarités des terminaux ainsi que le câblage des enceintes pendant le fonctionnement afin d'assurer une utilisation sécurisée.

INTRODUCTION & CONTENTS

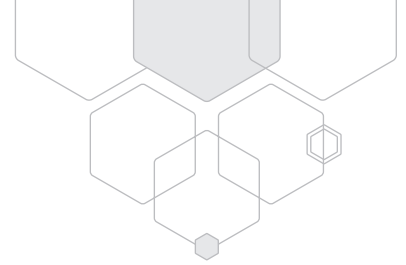

XRS SERIES

The Australian Monitor XRS series of two-way injection moulded speakers are specifically designed to suit both live sound reinforcement and permanent installation. From front-of-house to fold back, the dance floor to background fill, the XRS series with passive and powered options are designed with flexibility and performance in mind.

For outdoor applications there is also the ODV range. These models provide the same high performance as the passive models but are IP44 rated with zinc coated grills, captive cables and feature a built-in transformer for high or low impedance installation.

Both the passive and powered ranges include 8", 10" and 12" models, with high quality compression drivers and represent excellent audio quality and great value for money. The ODV range also includes a compact 6" version which is perfect for smaller outdoor areas.

| | |
|--|---|
| Introduction | 3 |
| XRS Front Panel | 4 |
| XRS Rear Panel – Passive & Constant Voltage | 5 |
| XRS Rear Panel – Powered Version | 6 |
| Mounting | 7 |
| Accessories | 8 |
| Specifications | 9 |

Version 2.0: August 2021

WARNING

TO PREVENT FIRE OR SHOCK HAZARD, DO NOT USE THE PLUG WITH AN EXTENSION CORD, RECEPTACLE OR OTHER OUTLET UNLESS THE BLADES CAN BE FULLY INSERTED TO PREVENT BLADE EXPOSURE.

TO REDUCE THE RISK OF FIRE OR ELECTRIC SHOCK, DO NOT EXPOSE THIS APPLIANCE TO RAIN OR MOISTURE.

TO PREVENT ELECTRICAL SHOCK, MATCH WIDE BLADE PLUG TO WIDE SLOT & FULLY INSERT.

CAUTION

TO REDUCE THE RISK OF ELECTRIC SHOCK DO NOT PERFORM ANY SERVICING OTHER THAN THAT CONTAINED IN THE OPERATING INSTRUCTIONS UNLESS YOU ARE QUALIFIED TO DO SO.



The lightning flash with arrowhead symbol, within an equilateral triangle, is intended to alert the user to the presence of uninsulated "dangerous voltage" within the product's enclosure that may be of sufficient magnitude to constitute a risk of electric shock to persons.



WARNING

TO REDUCE THE RISK OF ELECTRIC SHOCK, DO NOT REMOVE COVER (OR BACK). NO USER SERVICEABLE PARTS INSIDE. REFER SERVICING TO QUALIFIED SERVICE PERSONNEL.



The exclamation point within an equilateral triangle is intended to alert the user to the presence of important operating and maintenance (servicing) instructions in the literature accompanying the appliance.



For European Union countries: This symbol on the product or its packaging indicates that this product must not be disposed of with other waste. Instead, it is your responsibility to dispose of your waste equipment by handing it over to a designated collection point for the recycling of waste electrical and electronic equipment. Please contact your local authority for further details of your nearest designated collection point.

Rating plate and caution marking are marked on the back enclosure of the apparatus

FRONT PANEL

All versions

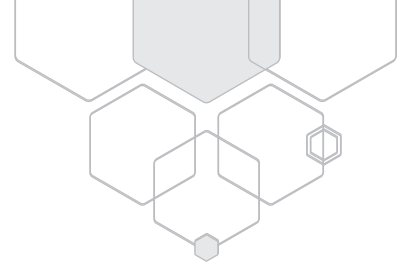

XRS8 shown here

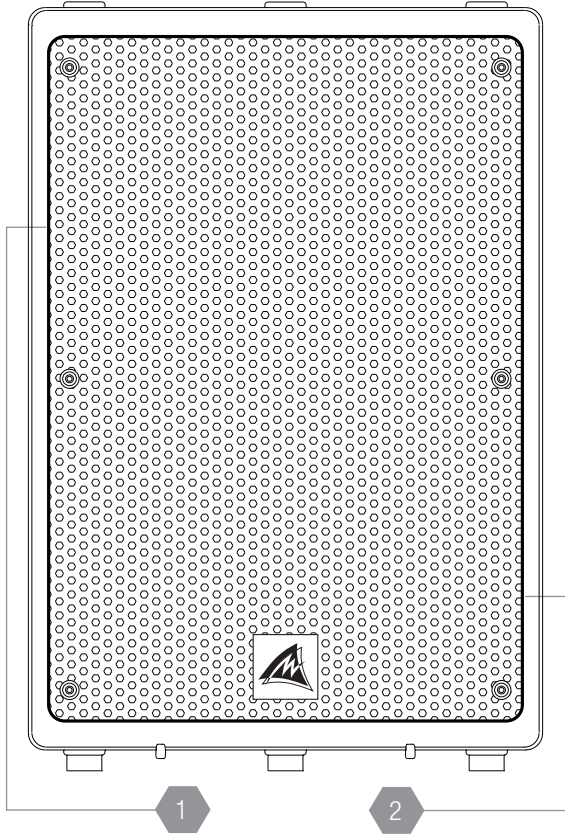

1 High Frequency Driver

Horn loaded compression driver.

Dispersion 90° H x 60° V for XRS6ODV
and 90° H x 90° V for all other models

Passive crossover in the passive and outdoor XRS variants.

| | |
|---------|------|
| XRS6ODV | 1" |
| XRS8 | 1.5" |
| XRS10 | 1.5" |
| XRS12 | 2" |

Active crossover and power amp in XRS powered variants.

| | |
|--------|-------|
| XRS8P | 50 W |
| XRS10P | 50 W |
| XRS12P | 100 W |

2 Low Frequency Woofer

Driver sizes:

| | |
|---------|-----|
| XRS6ODV | 6" |
| XRS8 | 8" |
| XRS10 | 10" |
| XRS12 | 12" |

REAR PANEL

Passive and Constant Voltage



XRS8B shown here

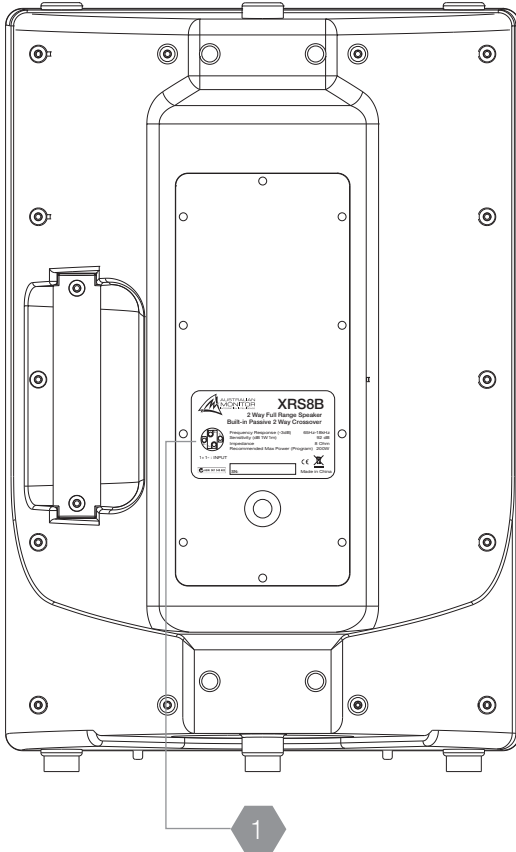

XRS8ODV shown here

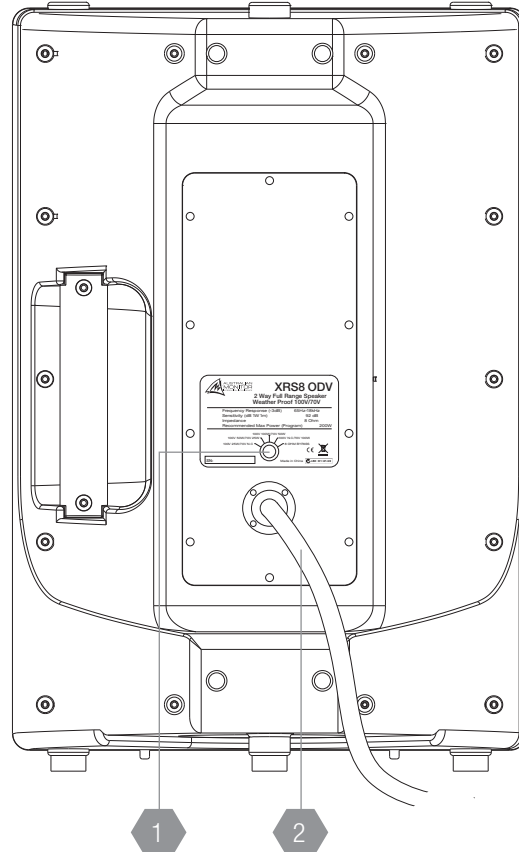

1 Speaker Input

The input connector is a 4 pole twist lock, speakON compatible connector. Pins 1+ and 1- are wired to +ve and -ve respectively of the speaker. The XRS10 and XRS12 have two connectors. They are wired in parallel so either connector can be used as an input, the other as a loop through.

1 Voltage Tap Select Switch

A switch on the back of the XRS ODV speakers allows you to select the desired transformer tap. Each speaker has 3 taps at 70 V and 100 V, as well as a low impedance transformer bypass option.

2 Fly Lead (Speaker Input)

The XRS ODV series speakers come supplied with a 2 core flying lead as input to the speaker. The flying lead wires are red (positive +) and black (negative -) and are used as an input to the speaker for both constant voltage and low impedance inputs.

REAR PANEL

Powered Version

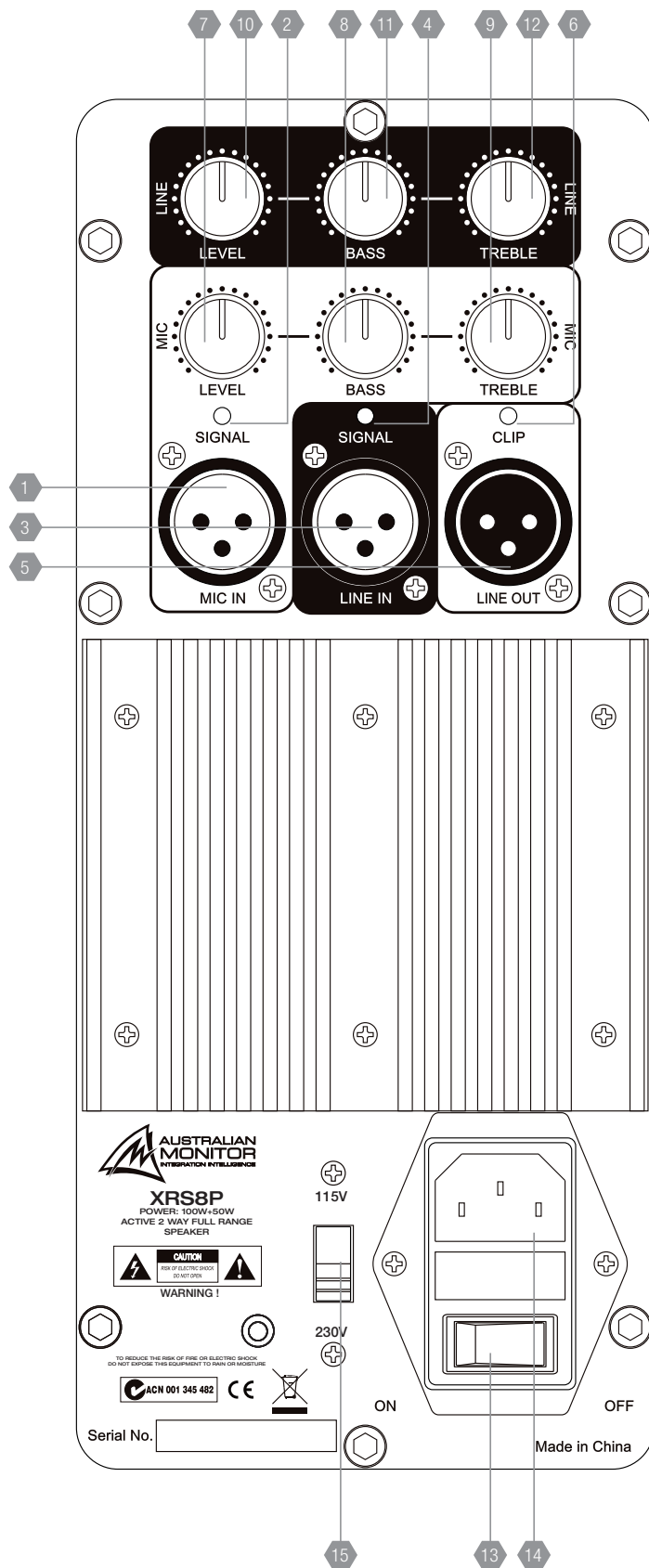

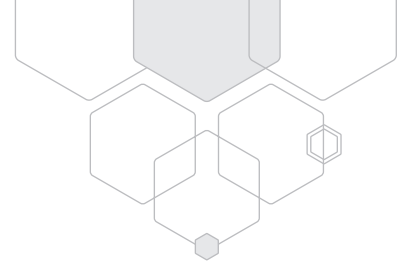





- 1 **Mic In**
Balanced XLR microphone input.
- 2 **Mic Signal**
Green LED Signal Present indicator for the Mic input. It indicates signal present on the input and is not affected by the level control.
- 3 **Line In**
Balanced XLR line level input.
- 4 **Line Signal**
Green LED Signal Present indicator for the Line input. Indicates signal is present at the input, it is not affected by the level control.
- 5 **Line Out**
LINE OUT is a line level output. This output can be connected to the LINE IN on another XRS Powered speaker to expand the system.
- 6 **Output Clip**
Red LED clip indicator for mixed mic and line audio signals. Some flashing of red is acceptable on program transients. Continuous flashing of red could indicate that undue stress is being placed on the speaker and will sound distorted. Turn down the input level until the clip LED is no longer lit.
- 7 **Mic Level**
Controls the level of the MIC input (1).
- 8 **Mic Bass**
Bass control for the MIC input (1). There is 12 dB of cut and boost at 100 Hz. This EQ is the shelving type.
- 9 **Mic Treble**
Treble control for the MIC input (1). There is 10 dB of cut and boost at 10 kHz. This EQ is the shelving type.
- 10 **Line Level**
Controls the level of the LINE input. (3)

- 11 **Line Bass**
Bass control for the LINE input (3). There is 12 dB of cut and boost at 100 Hz. This EQ is the shelving type.
- 12 **Line Treble**
Treble control for the LINE input (3). There is 10 dB of cut and boost at 10 kHz. This EQ is the shelving type.
- 13 **Power Switch**
Mains power switch to turn the speaker amplifier on and off.
- 14 **IEC Mains Input Socket**
XRS series powered speakers use a standard IEC 3 pin mains socket. A standard IEC mains cable is provided. The fuse drawer contains the mains fuse and a spare. The mains fuse is a time lag (slow blow) HRC 20 x 5 mm ceramic or glass type fuse.

| | XRS8P | XRS10P | XRS12P |
|-------|--------------|---------------|---------------|
| 115 V | 2.5 A | 2.5 A | 3.15 A |
| 230 V | 1.6 A | 1.6 A | 5.0 A |

-  **IMPORTANT:** Always replace the fuse with one of the same value and type.
-  **NOTE:** Always disconnect power to the amplifier before replacing fuses.
- 15 **Voltage Select Switch**
This switch selects the mains voltage for your region. Choose either 230V or 115V.
-  **IMPORTANT:** Disconnect power to the amplifier before operating this switch.
-  **IMPORTANT:** Always ensure that the correct voltage for your area has been chosen before connecting the unit to the mains supply. Failure to do so may result in personal injury or damage to the unit.

MOUNTING

 When mounting XRS series loudspeakers the following safety issues must be considered;

1. The mounting of a permanently installed speaker may be dangerous unless undertaken by a qualified professional with relevant experience.
2. Walls and mounting surfaces must be capable of supporting the speaker and bracketry in a safe and secure manner.
3. Fixings must be safely attached to the speaker cabinet and the mounting surface. All fixings must be installed in accordance with the manufacturer's instructions and specifications.

Suspending with Eyebolts

As many eyebolt locations as possible should be used on the speaker.

XRS6ODV or XRS8 speaker cabinet, at least two or more mounting points must be used.

XRS10 and XRS12 speaker cabinets, three or more points must be used.

The best way to hang a speaker using eyebolts is to use two eyebolts on the top of the cabinet and one on the rear to give the speaker some angle.

All eyebolt fittings in the XRS range are M8 and require at least a 20 mm of thread length.

ACCESSORIES

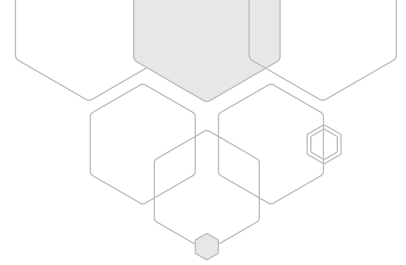

XRS6ODV

| PART | DESCRIPTION |
|--------|--------------------|
| XR6PMA | Pole mount adaptor |

XRS8

| PART | DESCRIPTION |
|--------|----------------------------|
| XR8PMA | Pole mount adaptor |
| XR8UMB | Universal mounting bracket |

XRS10

| PART | DESCRIPTION |
|-----------|---------------------------------|
| XR10CVR | Heavy duty cover |
| AMISLSB2 | Wall mount brackets |
| ATC303 | Tripod speaker stand |
| ATC304 | Heavy duty tripod speaker stand |
| ATC305 | Winch up speaker stand |
| XR10-12UB | Universal bracket |

XRS12

| PART | DESCRIPTION |
|-----------|---------------------------------|
| XR10CVR | Heavy duty cover |
| AMISLSB2 | Wall mount brackets |
| ATC303 | Tripod speaker stand |
| ATC304 | Heavy duty tripod speaker stand |
| ATC305 | Winch up speaker stand |
| XR10-12UB | Universal bracket |

SPECIFICATIONS

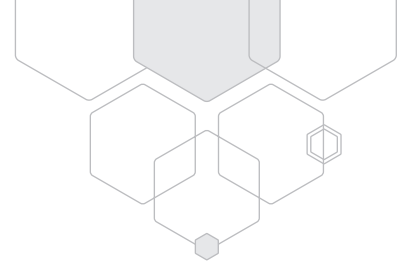

| PASSIVE MODELS | XRS8 | XRS10 | XRS12 |
|---|---|---|---|
| IMPEDANCE | 8 Ohms | 8 Ohms | 8 Ohms |
| POWER (CONTINUOUS, PROGRAM) | 100 W, 200 W | 250 W, 500 W | 300 W, 600 W |
| SENSITIVITY (1 W / 1 M) | 92 dB | 95 dB | 97 dB |
| CALCULATED MAX SPL (CONTINUOUS, PEAK) | 112 dB, 118 dB | 119 dB, 125 dB | 121 dB, 128 dB |
| DISPERSION (-6 dB POINTS) (H X V) | 90° x 90° | 90° x 90° | 90° x 90° |
| FREQUENCY RESPONSE (-3 dB) | 65 Hz - 18 kHz | 55 Hz - 18 kHz | 50 Hz - 18 kHz |
| FREQUENCY RESPONSE (-10dB) | 60 Hz - 20 kHz | 50 Hz - 20 kHz | 40 Hz - 20 kHz |
| CONNECTION | 4 pole twist lock connectors | 4 pole twist lock connectors | 4 pole twist lock connectors |
| COMPONENTS | 1 x 8" Woofer, 1 x 1.5" HF Driver | 1 x 10" Woofer, 1 x 1.5" HF Driver | 1 x 12" Woofer, 1 x 2" HF Driver |
| NET DIMENSIONS (W X D X H) (per single) | 277 x 257 x 400 mm (10.9" x 10.1" x 15.7") | 321 x 308 x 464 mm (12.6" x 12.1" x 18.3") | 415 x 382 x 620 mm (16.3" x 15.0" x 24.4") |
| SHIPPING DIMENSIONS (W X D X H) (per pair) | 595 x 310 x 460 mm (23.4" x 12.2" x 18.1") | 375 x 355 x 535 mm (14.8" x 14" x 21.1") | 465 x 435 x 680 mm (16.3" x 15.4" x 23.6") |
| NET WEIGHT (per single) | 6.5 kg (14.3 lbs) | 10 kg (22 lbs) | 18 kg (39.7 lbs) |
| SHIPPING WEIGHT (per pair) | 15 kg (33.1 lbs) | 12 kg (26.5 lbs) | 20 kg (44.1 lbs) |

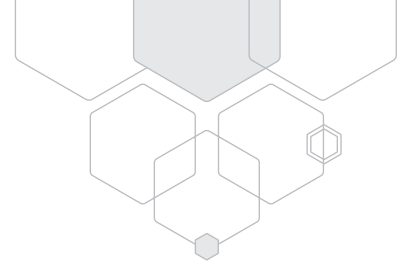

| POWERED MODELS | XRS8P | XRS10P | XRS12P |
|--|---|---|---|
| CALCULATED MAX SPL (CONTINUOUS, PEAK) | 112dB, 118 dB | 119 dB, 125 dB | 121.8 dB, 127.8 dB |
| DISPERSION (-6 dB POINTS) (H X V) | 90° x 90° | 90° x 90° | 90° x 90° |
| FREQUENCY RESPONSE (-3 dB) | 65 Hz - 18 kHz | 55 Hz - 18 kHz | 50 Hz - 18 kHz |
| FREQUENCY RESPONSE (-10dB) | 55 Hz - 18 kHz | 50 Hz - 18 kHz | 40 Hz - 20 kHz |
| AMPLIFIER TYPE | Class AB | Class AB | Class AB |
| POWER REQUIREMENTS (VAC) | 115/230 V, 50/60 Hz | 115/230 V, 50/60 Hz | 115/230 V, 50/60 Hz |
| POWER OUTPUT | 100 W (LF) + 50 W (HF) | 100 W (LF) + 50 W (HF) | 300 W (LF) + 100 W (HF) |
| CONNECTION | 3 Pin XLR | 3 Pin XLR | 3 Pin XLR |
| COMPONENTS | 1 x 8" Woofer, 1 x 1.5" HF Driver | 1 x 10" Woofer, 1 x 1.5" HF Driver | 1 x 12" Woofer, 1 x 2" HF Driver |
| NET DIMENSIONS (W X D X H) | 277 x 257 x 400 mm (10.9" x 10.1" x 15.7") | 321 x 308 x 464 mm (12.6" x 12.1" x 18.3") | 415 x 382 x 620 mm (16.3" x 15.0" x 24.4") |
| SHIPPING DIMENSIONS (W X D X H) | 355 x 325 x 470 mm (14" x 12.8" x 18.5") | 375 x 355 x 535 mm (14.8" x 14" x 21.1") | 465 x 435 x 680 mm (16.3" x 15.4" x 23.6") |
| NET WEIGHT | 8.6 kg (19 lbs) | 10.5 kg (23.1 lbs) | 23 kg (51 lbs) |
| SHIPPING WEIGHT | 10.1 kg (22.3 lbs) | 11.8 kg (26 lbs) | 25.2 kg (55.6 lbs) |

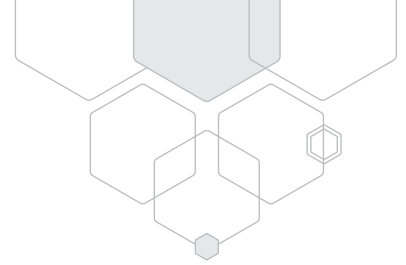

| OUTDOOR MODELS | XRS6ODV | XRS8ODV |
|---------------------------------------|--|--|
| IMPEDANCE (Bypass) | 8 Ohms | 8 Ohms |
| POWER (70 V, 100 V Tappings) | 7.5 W, 15 W, 30, 60 W | 15 W, 37.5 W, 75 W |
| POWER (Bypass Continuous / Program) | 80 W, 160 W | 100 W, 200 W |
| SENSITIVITY (1 W / 1 M) | 92 dB | 92 dB |
| CALCULATED MAX SPL (CONTINUOUS, PEAK) | 111 dB, 117 dB | 112 dB, 118 dB |
| DISPERSION (-6 dB POINTS) (H X V) | 90° x 60° | 90° x 90° |
| FREQUENCY RESPONSE (-3 dB) | 95 Hz - 18 kHz | 65 Hz - 18 kHz |
| FREQUENCY RESPONSE (-10dB) | 85 Hz - 20 kHz | 60 Hz - 20 kHz |
| CONNECTION | Captive Fly Lead | Captive Fly Lead |
| COMPONENTS | 1 x 6" Woofer 1 x 1" HF Driver | 1 x 8" Woofer, 1 x 1.5" HF Driver |
| NET DIMENSIONS (W X D X H) | 225 x 200 x 325 mm (8.9" x 7.9" x 12.8") | 277 x 257 x 400 mm (10.9" x 10.1" x 15.7") |
| SHIPPING DIMENSIONS (W X D X H) | 260 x 260 x 390 mm (10.2" x 10.2" x 15.4") | 355 x 325 x 470 mm (14" x 12.8" x 18.5") |
| NET WEIGHT (per single) | 7 kg (15.4 lbs) | 10 kg (22 lbs) |
| SHIPPING WEIGHT (per pair) | 8.2 kg (18 lbs) | 12 kg (26.5 lbs) |

| OUTDOOR MODELS | XRS10ODV | XRS12ODV |
|---------------------------------------|--|--|
| IMPEDANCE (Bypass) | 8 Ohms | 8 Ohms |
| POWER (70 V, 100 V Tappings) | 37.5 W, 75 W, 150 W | 37.5 W, 75 W, 150 W, 300 W |
| POWER (Bypass Continuous / Program) | 250 W, 500 W | 300 W, 600 W |
| SENSITIVITY (1 W / 1 M) | 95 dB | 97 dB |
| CALCULATED MAX SPL (CONTINUOUS, PEAK) | 119 dB, 125 dB | 121 dB, 127 dB |
| DISPERSION (-6 dB POINTS) (H X V) | 90° x 90° | 90° x 90° |
| FREQUENCY RESPONSE (-3 dB) | 55 Hz - 18 kHz (8 Ohm Bypass) | 50 Hz - 18 kHz (8 Ohm Bypass) |
| FREQUENCY RESPONSE (-10dB) | 50 Hz - 20 kHz (8 Ohm Bypass) | 40 Hz - 20 kHz (8 Ohm Bypass) |
| CONNECTION | Captive Fly Lead | Captive Fly Lead |
| COMPONENTS | 1 x 10" Woofer, 1 x 1.5" HF Driver | 1 x 12" Woofer, 1 x 2" HF Driver |
| NET DIMENSIONS (W X D X H) | 321 x 308 x 464 mm (12.6" x 12.1" x 18.3") | 415 x 382 x 620 mm (16.3" x 15.0" x 24.4") |
| SHIPPING DIMENSIONS (W X D X H) | 375 x 355 x 535 mm (14.8" x 14" x 21.1") | 465 x 435 x 680 mm (16.3" x 15.4" x 23.6") |
| NET WEIGHT (per single) | 16.5 kg (36.4 lbs) | 22 kg (48.5 lbs) |
| SHIPPING WEIGHT (per pair) | 18.5 kg (40.8 lbs) | 24 kg (52.9 lbs) |



ENGINEERED BY AUSTRALIAN MONITOR

Address: Unit 1, 2 Daydream Street, Warriewood NSW 2102 Australia

Website: www.australianmonitor.com.au

International enquiries email: international@australianmonitor.com.au

ABN 86 003 231 187