

## WP4S-EU WALL PANEL

WP4S-EU-W • WP4S-EU-B

The Australian Monitor WP4S-EU is a four-button programmable wall panel designed in a European/UK standard form factor.

Each button includes a momentary contact switch, an integrated status LED, and a spring-loaded security flip cover to prevent accidental activation.

When connected to compatible Australian Monitor products equipped with accessory ports, the buttons can be programmed to trigger tones, playback messages, or activate a range of system functions.



### FEATURES

- 4 momentary push buttons
- Integrated red status LEDs
- Spring-loaded security flip cover
- 12-24V DC operation
- RS485 communication port

WP4S-EU-W

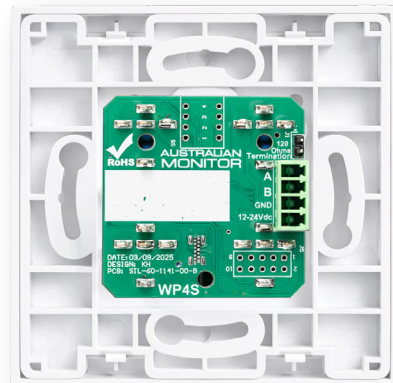
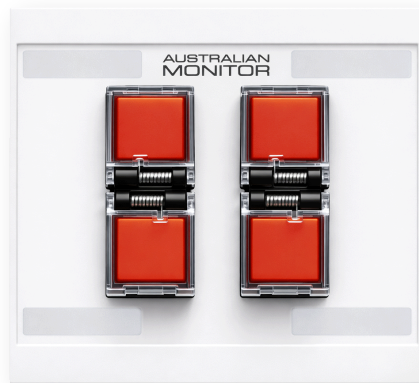

WP4S-EU-B

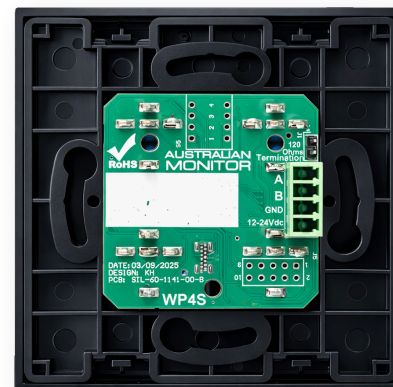

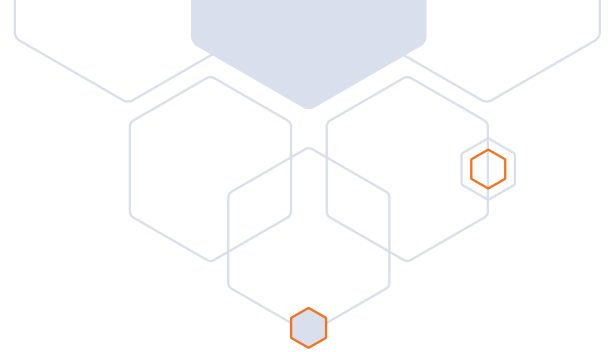

MODEL	WP4S-EU	COMMENTS
<b>GENERAL</b>		
USER CONTROLS	Momentary push button	
INPUT CONNECTORS	3.81mm 4way Euroblock (A, B, GND, 12-24V DC)	
PROGRAMMING INTERFACE	USB-C	PC Control Software
<b>POWER REQUIREMENTS</b>		
INPUT VOLTAGE	+12 to +24V DC	
INPUT CURRENT	12V = 19mA (All red LEDs On) 24V = 32mA (All red LEDs On)	
POWER CONSUMPTION	0.77W Max	
THERMAL DISSIPATION CONSUMPTION	2.63 BTU	1W = 3.412 BTU/Hr
<b>MECHANICAL</b>		
PRODUCT DIMENSIONS	86mm x 55mm x 86mm (3.4"W x 2.2"D x 3.4"H)	
SHIPPING DIMENSIONS	156 x 132 x 101mm (6.1"W x 5.2"D x 4"H)	
NET WEIGHT	90g (0.20Lbs)	
SHIPPING WEIGHT	0.2kg (0.5Lbs)	
FINISH	ABS Plastic	
COLOUR	White or Black	RAL 9010 / RAL 9005
OPERATING TEMPERATURE	0°C to 40°C (95% RH)	
<b>APPROVALS</b>		
	CE, IEC, RCM	



## LINE DRAWINGS

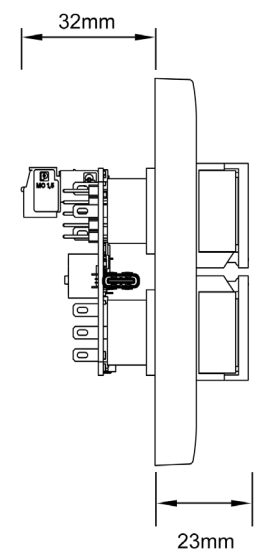
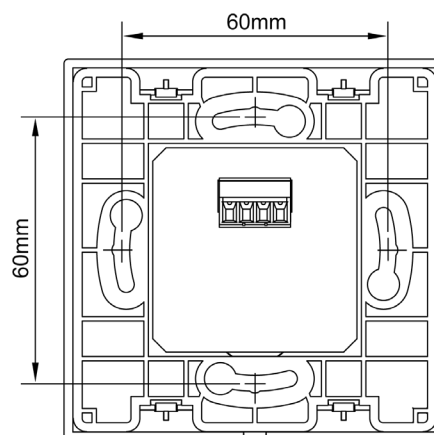
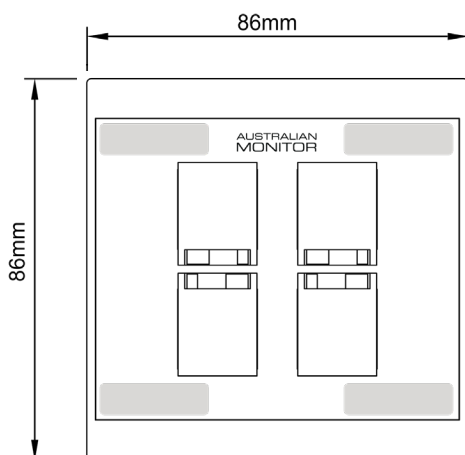

### ENGINEERED BY AUSTRALIAN MONITOR

Address: Unit 1, 2 Daydream Street, Warriewood NSW 2102 Australia

Website: [www.australianmonitor.com.au](http://www.australianmonitor.com.au)

International enquiries email: [international@australianmonitor.com.au](mailto:international@australianmonitor.com.au)

ABN 86 003 231 187